



UPS USER MANUAL

DRAGON POWER INT 1 KVA- 2 KVA



Español



English

www.lbspower.com

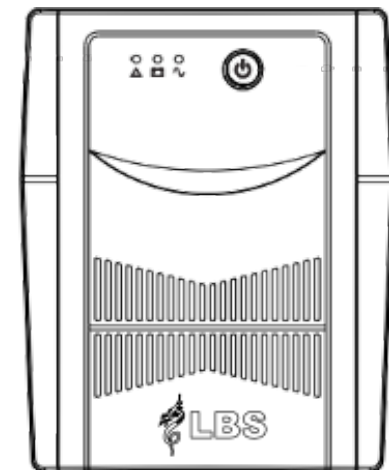

SAFETY – WARNING

- ★ This UPS utilizes voltages that may be hazardous. Do not attempt to disassemble the unit. The unit contains no user serviceable parts. Only factory service personnel may perform repairs.
- ★ Internal battery voltage is 12Vdc. Sealed, lead-acid, 6 cells battery.
- ★ Connection to any other type of receptacle other than a two-pole, three-wire grounded receptacle may result in shock hazard as well as violate local electrical codes.
- ★ In the event of an emergency, press the OFF button and disconnect the power cord from the AC power supply to properly disable the UPS.
- ★ Do not allow liquids or any foreign object to enter the UPS. Do not place beverages or any other liquid-containing vessels on or near the unit.
- ★ This unit intended for installation in a controlled environment (temperature controlled, indoor area free of conductive contaminants). Avoid installing the UPS in locations where there is standing or running water, or excessive humidity.
- ★ Do not plug the UPS input into its own output.
- ★ Do not attach a power strip or surge suppressor to the UPS.
- ★ Do not attach non-computer-related items, such as medical equipment, life-support equipment, microwave ovens, or vacuum cleaners to UPS.
- ★ To reduce the risk of overheating the UPS, do not cover the UPS cooling vents and avoid exposing the unit to direct sunlight or installing the unit near heat emitting appliances such as space heaters or furnaces.
- ★ Unplug the UPS prior to cleaning and do not use liquid or spray detergent.
- ★ Do not dispose of batteries in a fire as they may explode.
- ★ Do not open or mutilate the battery or batteries. Released electrolyte is harmful to the skin and eyes. It may be toxic.
- ★ A battery can present a risk of electrical shock and high short circuit current. The following precautions should be observed when working on batteries:
 - 1)Remove watches, rings, or other metal objects from the hands.
 - 2)Use tools with insulated handles.
 - 3)Wear rubber gloves and boots.
 - 4)Do not lay tools or metal parts on top of batteries.
 - 5)Disconnect charging source prior to connecting or disconnecting batteries terminals.
- ★ Servicing of batteries should be performed or supervised by personnel knowledgeable of batteries and the required precautions. Keep unauthorized personnel away from batteries.

SPECIFICATION

CAPACITY	KVA	1 KVA	2 KVA
INPUT	Voltage	110VAC/120VAC or 220VAC / 230VAC /240VAC	
	Voltage Range	81-145VAC or 162-290VAC	
OUTPUT	Voltage Regulation (Batt. Mode)	+/-10%	
	Frequency	50Hz or 60Hz	
	Frequency Regulation (Batt. Mode)	+/-1Hz	
	Output Waveform	Modified Sine wave	
BATTERY	Battery Type	12 V/7.0 AH x 2	12 V/9.0 AH x 2
	Recharge Time	6-8 hours to 90% after complete discharge	
TRANSFER TIME	Typical	2-6 ms	
INDICATOR	AC Mode	Green LED lighting	
	Battery Mode	Yellow LED Flashing	
	Fault Mode	Red LED Lighting	
AUDIBLE ALARM	Backup Mode	Sounding every 10 seconds	
	Low Battery	Sounding every 1 second	
	Overload	Sounding every 0.5 second	
	Fault	Continuously sounding	
PROTECTION	Full Protection	Discharge, overcharge, and overload protection	
PHYSICAL	Dimension (mm), LXWXH	353x149.3x162	380x158x198
WEIGHT	Net Weight(kgs)	7.8	10.5
ENVIRONMENT	Operating Environment	0°C - 40°C	
	Noise Level	Less than 40dB	

3. Placement

Install the UPS unit in any protected environment that provides adequate airflow around the unit, and is free from excessive dust, corrosive fumes and conductive contaminants. Do not operate your UPS in an environment where the ambient temperature or humidity is high.



On the other hand, place the UPS away from the monitor at least 20cm to avoid interference.

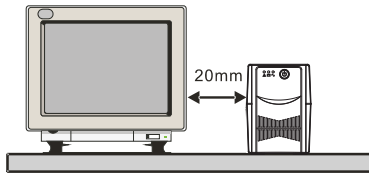

4. Connection

Plug the UPS into a 2-pole, 3-wire grounded receptacle. Then connect one computer-related device into each of the power receptacles supplied on the back of the UPS.

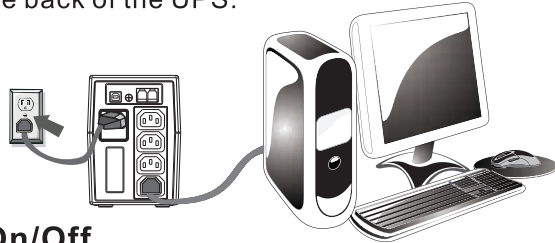

5. Turn On/Off

To turn on the UPS unit, press the power switch lightly. To turn off the UPS unit, press the power switch again.

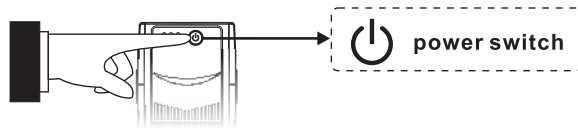

6. DC Start

All Series are equipped with DC Start. To start the UPS when AC utility power is not available, simply press the power switch.

- ★ When replacing batteries, replace with the same number and type of sealed lead-acid battery. The maximum ambient temperature rating is 40°C
- ★ This pluggable type A equipment with battery already installed by the supplier is operator installable and may be operated by laymen.
- ★ During the installation of this equipment it should be assured that the sum of the leakage currents of the UPS and the connected loads does not exceed 3.5mA.
- ★ Attention, hazardous through electric shock. Also with disconnection of this unit from the mains, hazardous voltage still may be accessible through supply from battery. The battery supply should be therefore disconnected in the plus and minus pole of the battery when maintenance or service work inside the UPS is necessary.
- ★ The mains socket outlet that supplies the UPS shall be installed near the UPS and shall be easily accessible.



INTRODUCTION

This UPS is specially designed for Personal Computer with multi-functions. Its light weight, compact design perfect fits to the limited working environment. The line of UPS is equipped with boost and buck AVR to stabilize input voltage range. It is also built-in with DC start function. This function enables the UPS to be started up without AC power supplied. Although it's a small UPS, The main features of UPS are listed below:

- Microprocessor control guarantees high reliability.
- Equipped with Boost and Buck AVR.
- Green Power Function for energy saving.
- DC Start Function.
- Auto restart while AC recovery.
- Compact size, Light Weight.
- Provides AC Overload protection.

TROUBLE SHOOTING

Symptom	Possible Cause	Remedy
No LED display on the front panel.	1. Battery weak.	1. Charge battery up to 8 hours.
	2. Battery defect.	2. Replace with the same type of battery.
	3. Power switch is not pressed.	3. Press the power switch again.

Alarm buzzer beeps continuously when AC supply is normal.	Overload of the UPS.	Verify that the load matches the UPS capability specified in the specs.
When power failure, back-up time is shorten.	1. Overload of the UPS.	1. Remove some non-critical load.
	2. Battery voltage is too low.	2. Charge battery 8 hours or more.
	3. Battery defect due to high temperature operation environment, or improper operation to battery.	3. Replace with the same type of battery.
Mains normal but Yellow LED is flashing.	Power cord is loose.	Reconnect the power cord properly.

If any abnormal situations occur that are not listed above, please call service people immediately.

SYSTEM DESCRIPTION

Front panel:

1. Power Switch

2. LED Indicators-

AC Mode: Green LED lighting

Battery Mode: Yellow LED Flashing

Fault Mode: Red LED Lighting

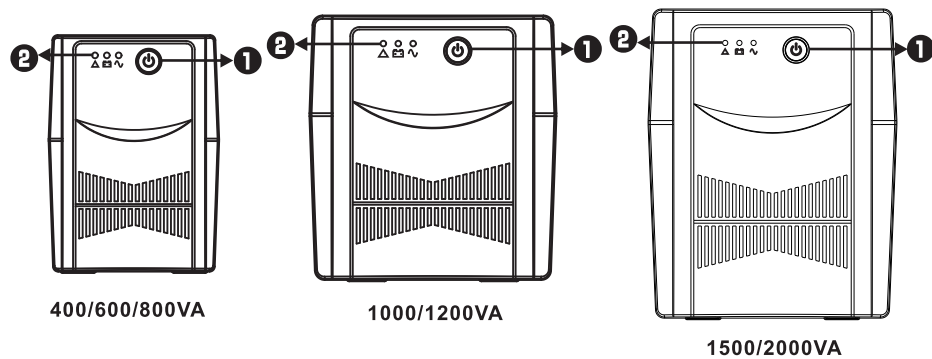

Back Panel:

1. AC input
2. Output receptacles
3. USB & RJ11 (optional)
4. USB & RS232 (optional)
5. RJ45 (optional)
6. Circuit breaker

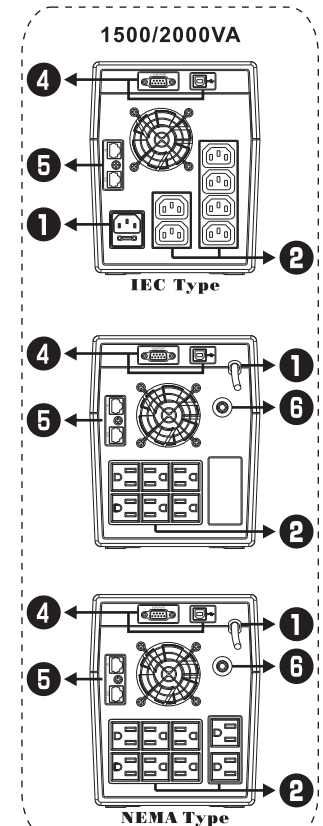
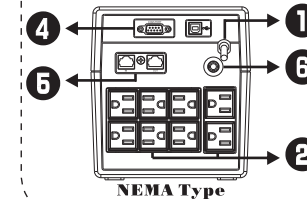
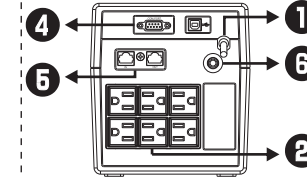
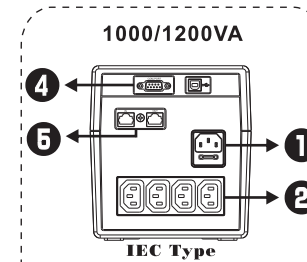
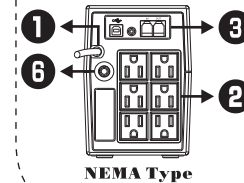
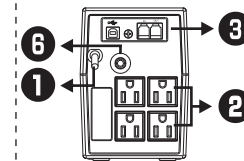
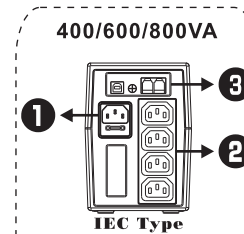

1. Inspection

Remove the UPS from its packaging and inspect it for damage that may have occurred during shipping. If any damage is discovered, repack the unit and return it to the place of purchase.

2. Charging

This unit is shipped from the factory with its internal battery fully charged, however, some charge may be lost during shipping and the battery should be recharged prior to use. Turn on the UPS, Plug the unit into an appropriate power supply and allow the UPS to charge fully by leaving it plugged in for at least 6 hours with no load (no electrical devices such as computers, monitors, etc.) connected.



6 hours

